

9. Clean any dirt from around the spark plug bases.  
Remove the spark plugs using the spark plug wrench (10) furnished in the tool kit.

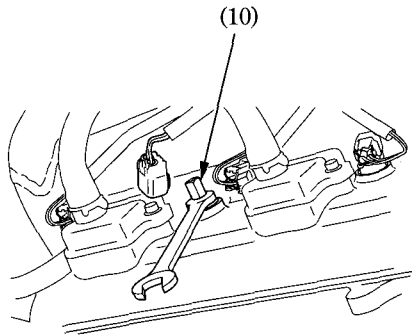

(10) Spark plug wrench

10. Inspect the electrodes and center porcelain for deposits, erosion or carbon fouling. If the erosion or deposit is heavy, replace the plug.
11. Make sure that the 1.0 mm wire-type feeler gauge does not insert between the spark plug gap (11). If the gauge is inserted into the gap, replace the plug with a new one.

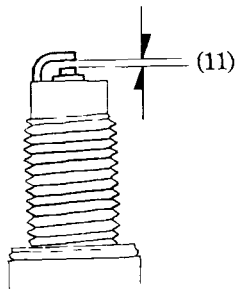

(11) Spark plug gap